

INSTALLATION INSTRUCTIONS

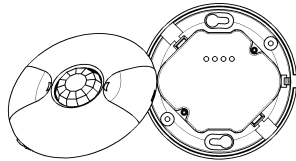

MPC-50V

360° Passive Infrared Line Voltage
Occupancy Sensor



SPECIFICATIONS

Incandescent.....	800W-120VAC, 60Hz
Flourescent.....	800VA-120VAC / 1600VA-277VAC, 60Hz
Resistive	10A, 120VAC, 60Hz
Motor.....	1/4 HP, 120VAC, 60Hz
Operating Temperature	32°F to 131°F (0°C to 55°C)
Adjustable Light Level	10FC—150FC
Adjustable Time Delay	15 sec.-30min
PIR Adjustment.....	50% or 100% (DIP switch 1)
Coverage.....	Up to 1200 ft²

DESCRIPTION

The MPC-50V 360° occupancy sensor uses advanced PIR technology to turn on the lights when motion is detected and keep the lights on when movement is present. The sensor will automatically turn off the lights if no movement is detected within the amount of time selected in the time delay.

COVERAGE

The MPC-50V provides a 360° coverage pattern, up to 1200 square feet. The diagram below shows the range of detection with the sensor mounted at a height of 8 feet. The sensor is designed to detect a heat-emitted movements across its range of view. Obstructions and low levels of movements may hinder the level of detection.

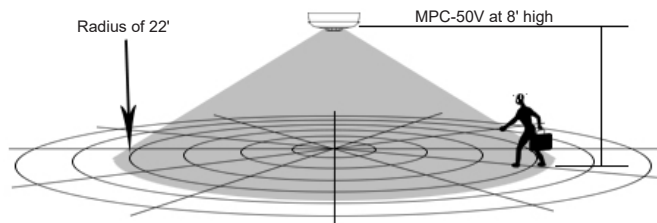

1

Location: Device should be mounted in a location free of obstruction from furniture, plants, walls and vibration (see Figure 1). The sensor must be mounted a minimum of 4 ft. away from any air vents. Avoid mounting the sensor close to heat source. When mounting directly to a ceiling light fixture, the lens of the sensor must be below the lowest point of the fixture.

MPC-50V is designed for a ceiling height of about 8-10 feet. Because of the umbrella shaped coverage pattern, mounting above or below the recommended height could reduce coverage range and sensitivity. It is not necessary to have occupancy sensor coverage on every square inch of space in any particular room.

The best location to install multiple MPC-50V is usually in the walkways of an open office space (see Figure 2).

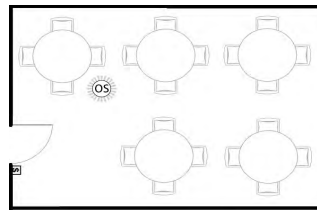

Figure 1

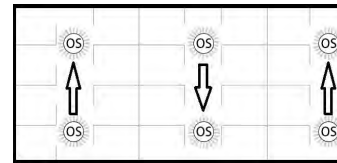

Figure 2

Helpful hints:

- Make sure that the sensor's view of the entrance will not be blocked by the door when it is open.
- Program a longer time out to avoid the lights constantly turning on/off.
- Do not mount sensors close to air vents.
- Cover the main walkways.
- Try to avoid having the sensor looking out the door of the space

Open Office or Classroom Area Coverage:

- To get complete coverage in an open office area, install multiple sensors so that there is at least 15% overlap with each adjacent sensor's coverage area.
- The sensors should cover the primary occupant's desk, the entrance and any other areas with heavy traffic.

WARNING

Turn the POWER OFF at the circuit breaker before installing the sensor

Read and understand these instructions before installing. This device is intended for installation in accordance with the National Electric Code and local regulations. It is recommended that a qualified electrician performs this installation. Make sure to turn off the circuit breaker or fuse(s) and make sure power is off before wiring the device. Use copper wire only, or equivalent.

2

WIRING DIRECTIONS

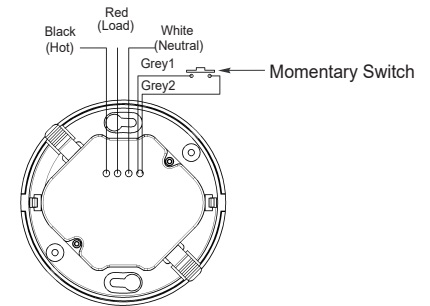

- Connect the Hot wire to the Black wire on the sensor.
- Connect the Load wire to the Red wire on the sensor.
- Connect the Neutral wire to the White wire on the sensor.
- You can add a MANUAL SWITCH to the sensor by connecting the two Grey wires to a momentary switch. Cap off if not being used.
(Step 4 is not necessary if you don't want to use the function of MANUAL ON/OFF)

LIGHT LEVEL ADJUSTMENT

The sensor may be adjusted to operate at the desired level of ambient light.

To do so, turn the dial to point the arrow toward the "-" sign for sensor to detect motion and operate during low light or no light. Point the arrow toward the "+" sign for sensor to operate when there's more light in the area or even during daylight.

NOTE: The light level is adjustable only when the time delay is set at or above 30 seconds.

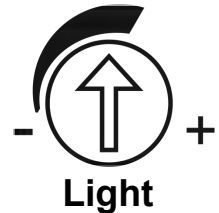

SENSOR ADJUSTMENT

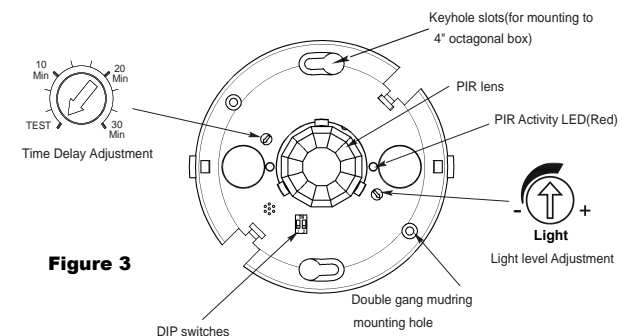

Figure 3

3

INSTALLATION

Using an Octagonal J-box (not included)

1. Pull the low voltage wires from the power pack into the J-Box through the conduit knockout.
2. Connect the low voltage wires to the appropriate terminals on the sensor.
3. Loosen the appliance mounting screws attached to the J-Box.
4. Align the sensor to the J-Box so that the mounting screws on the box match the key holes on the sensor's Main Body.
5. Push the sensor up into the J-Box and twist it so that the mounting screws are seated in the keyhole slots.
6. Tighten the two screws to secure the sensor to the J-Box.
7. Snap on the front cover onto the sensor.

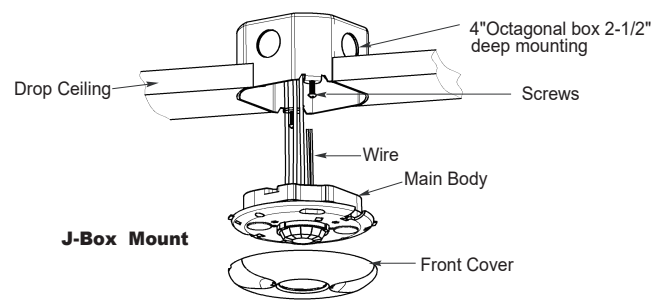

Mounting Option (not included): Auxiliary Mounting Adapter for Ceiling Sensor

Model	Description
MPC-A	The Auxiliary Mounting Adapter allows you to mount the ceiling sensor onto boxes such as 4" and 5" square junction box.

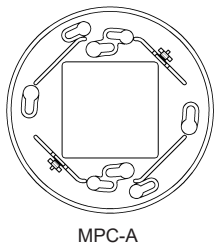

TESTING OCCUPANCY SENSOR

Note: There is a 40-second warm-up period when power is first applied. Use a small screwdriver to open the front cover and make changes to the settings. The pre-set time delay is Test mode and light level is set at maximum

- Refer to Figure 3 on previous page.
1. Ensure the PIR Activity is enabled, red LED flashes, and PIR Sensitivity is set to 100% (DIP switch 1 OFF).
 2. Ensure the Time Delay is set for Test Mode.
 3. Ensure that the Light Level is at the maximum position. (see "LIGHT LEVEL ADJUSTMENT").
 4. Remain still. The red LED should not flash. The lights should turn off after 15 seconds. (If not, see "TROUBLESHOOTING.")
 5. Move in the front of coverage area. The lights should turn on automatically. When functional test is complete, set DIP Switches, Time Delay and Light Level to the desired settings, and put the front cover back on the sensor.

DIP SWITCH SETTING

The MPC-50V has 2 DIP switches under the cover. They are used to set the sensitivity and vacancy mode.

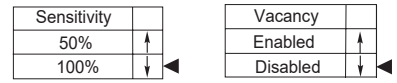

Sensitivity setting: DIP switch 1

- 50% - This setting will decrease the amount of area the sensor will cover to half the range
- 100% , the maximum range of sensor's coverage is 1200 square feet, see "coverage pattern"

Vacancy Mode: Switch 2

Manual on/off function is achieved by using a momentary switch, such as model number 91245 (not included) from Enerlites. The switch must be connected to the two Gray wires on the sensor. The load can be operated by pressing the momentary switch. The operation of the sensor with a manual switch depends on the DIP Switch 2 setting.

1. Vacancy Enabled: In this mode, the load will not turn on automatically. Press the momentary switch to turn on the load. Movement will keep the load on. After the selected time delay has expired, the load will turn off. It will however, turn back on if there is movement within 30 seconds of it turning off.
2. Vacancy Disabled: In this mode, the sensor will turn the load ON automatically when motion is detected. The manual switch will operate as follow:
 - The light can be turned ON/OFF manually by pressing the momentary switch at any time. The lights will stay on as long as movement is detected. If no movement is detected when the programmed time delay has expired, the lights will turn off automatically.
 - When the lights are turned OFF by the manual switch, the lights will stay off until the time delay has expired. After the time delay has expired, the sensor will switch back to Automatic ON mode.

TROUBLESHOOTING

NOTE: There is a 40 seconds warm-up time at initial power-up. LED does not blink:

1. Check that the circuit breaker has been turned back on.
2. Make sure that the PIR Sensitivity is set for 100% (DIP switch 1).
3. Check all the wire connections. The Grey wires

LED blinks but lights do not turn ON:

1. Check the "Light" setting. If the arrow is pointed to the "-" position, the area needs to be dark enough for the sensor to operate. Cover the light sensor lens to simulate darkness. If the light turns ON, the light level setting needs to be adjusted.
2. Make sure the wires are connected and bulbs are working.
3. Check for obstructions in the lens cover.
4. Make sure that power to the sensor has been ON continuously for at least one minute. Wait for the warm-up period to end.

Lights do not turn OFF automatically:

1. If there is no motion from people or equipment in the sensor's view but the LED blinks, look for any nearby source of infrared energy (heat) in motion, such as turbulent air from a heating or cooling supply.
 - a. Mount the sensor so that its lens is below the edge of the fixture and does not directly view the lamps.
 - b. Move the air supply away from the sensor, or move the sensor.
2. Verify the time delay settings in switches 2-4. Ensure that the time delay is set to the desired delay and that there is no movement within the sensor's view for that time period.
3. Check sensor wire connections.
 - a. Disconnect power pack's blue wire:
 - b. If the lights do not turn off, replace power pack.
 - c. If the lights turn off, the problem may be in the sensor. To check:
 - i. Reconnect the blue wire.
 - ii. Turn sensitivity and time delay to minimum and test the functionality. If the lights turn off, the sensor is working properly.

WARRANTY INFORMATION

This device is warranted to be free of material and workmanship defects for 2 years from the date of purchase. Original receipt or proof of purchase from an authorized retailer must be presented upon warranty claim. ALL claims must be verified and approved by Enerlites, Inc. Warranties from other Enerlites products may vary. This warranty is nontransferable and does not cover normal wear and tear or any malfunction, failure, or defect resulting from misuse, abuse, neglect, alteration, modification, or improper installation. To the fullest extent permitted by the applicable state law, Enerlites shall not be liable to the purchaser or end user customer of Enerlites products for direct, indirect, incidental, or consequential damages even if Enerlites has been advised of the possibility of such damages. Enerlites' total liability under this or any other warranty, express or implied, is limited to repair, replacement or refund. Repair, replacement or refund are the sole and exclusive remedies for breach of warranty or any other legal theory.

