

Project: _____
 Part#: _____
 Type: _____

EXT SnapTrim Downlight

EnVision LED has developed a line of super slim LED downlights that eliminate the need for a can. The external remote junction box mounts inside the ceiling and the fixture is IC Rated. EnVisions EXT SnapTrim downlights feature three interchangeable trims, including black, bronze, and brushed nickel. By reducing material cost and installation time, the EnVision SnapTrim is the ideal retrofit or new construction recessed lighting solution yet. Simply cut a hole in the ceiling, power the J-Box to the wall switch, and “snap” the trim flush.

Applications:

- Retrofitting
- New Construction
- Residential Lighting
- Commercial Lighting

Product Information:

- External j-box & spring mount clips for easy installation
- ‘-TRI’ version toggles between 3000k, 4000k, & 5000k
- Compatible with most dimmers (e.g. Lutron DVCL-153P)
- Spring mount clips make installation easy
- Canless module does not require housing



LED - SL - PNL - Size/Shape/Watts - TRI - Driver - Trims - Control - EMB - Warranty

1	Product	2	Size/Shape/Watts	3	Color	4	Driver	5	Trims	6	Control	7	EMB	8	Warranty
	LED-SL-PNL Non-Adjustable	4R-11W	4" Round, 11W (600lm)	TRI	Variable	(Blank)	120V	WHT	White (incl.)	(Blank)	None	(Blank)	None	(Blank)	5 Year (incl.)
		4SQ-11W	4" Square, 11W (600lm)		30K / 40K / 50K	0/10V	0-10V Dim	BLK	Black	SWF	Wi-Fi Controller	EMB	Emergency Backup	10YR	10 Year
		6R-14W	6" Round, 14W (1000lm)				(120V-277V)	BZ	Bronze						
		6SQ-14W	6" Square, 14W (1000lm)					BN	Brushed Nickel						
		8R-18W	8" Round, 18W (1200lm)												

See pg. 4 for full list of accessories

FEATURES

Durable Aluminum Body

Eliminate heat with a die-cast aluminum heat sink

Quick Connector

Extend distance between driver and fixture

Tri-Color Switch

Easily switch between 30/40/50k color temp.

Easy Installation

Tension Spring Clips

Frosted PC Diffuser

Diffused light makes the recessed downlight easy on the eyes

Knockout

1/2" knockout makes it easy to connect power to the driver

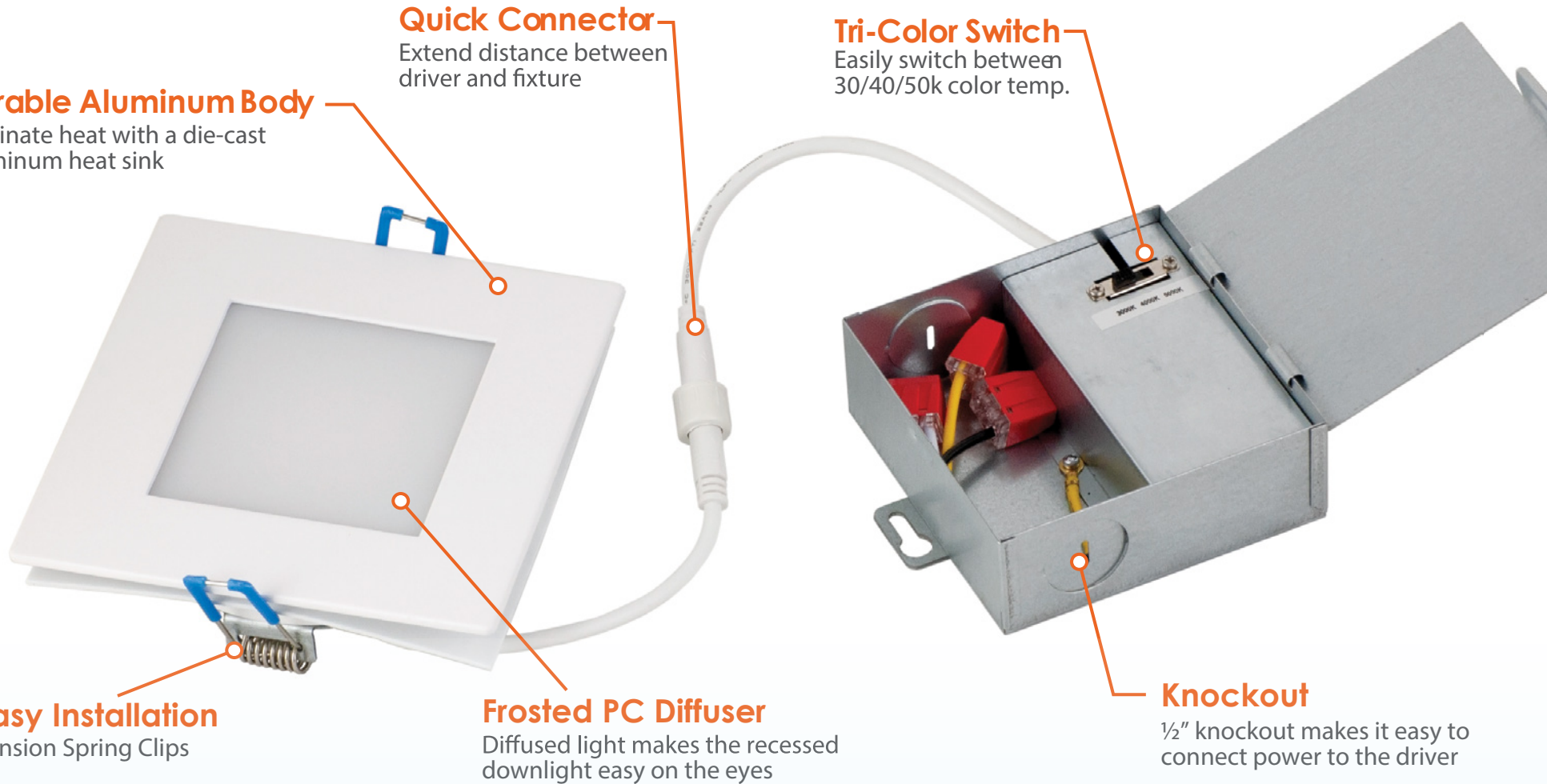

INSTALLATION

The slim panel LED redefines recessed downlighting installations. With the narrow design and remote driver box, the panel LED can be installed in confined, hard to reach spaces such as closets, bathrooms, hallways, stairwells, outside soffits and other areas that would have been nearly impossible with traditional recessed housings.

Make installation quick and simple with EXT SnapTrim series LED fixtures

Traditional recessed downlight

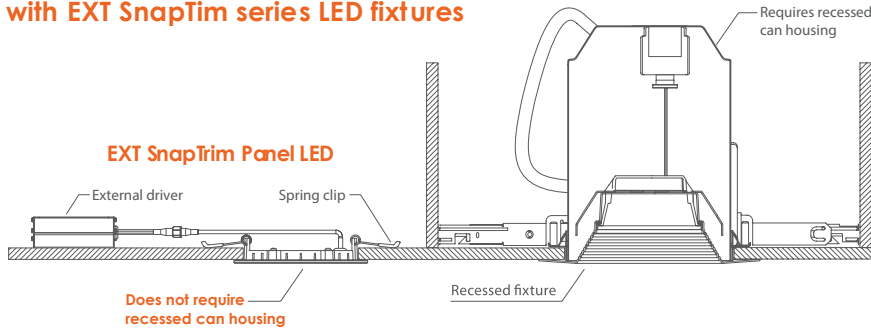

DIMMER COMPATIBILITY				
Brand	Series	Model	Load	Dimmability
Lutron	Ariadni	AYCL-153P	150W	OK
	Diva	DV-600PR	600W	OK
	Diva	DVCL-153P	150W	OK
	Maestro	MACL-153MH	600W	OK
	Maestro Wireless	MRF2-6CL	150W	OK
	Rotary	D-600P	600W	OK
	Electronic(ELV)	NTELV-300P	600W	OK
	Skylark	S-600P	600W	OK
	Skylark Contour	CT-600P	600W	OK
	Skylark Contour	CTCL-153P	150W	OK
Leviton	Sureside	6633	600W	OK
	Sureside Decora	6674	600W	OK
	Trimatron	6672	600W	OK
	Sureside	6613	600W	OK
Legrand	Adorne	DLV 703	700W	OK
	Harmony	H703PTW	700W	OK
Cooper	Aspire	9530	1000W	OK
	Devine	DAL03P	300W	OK

DIMENSIONS

4" Round

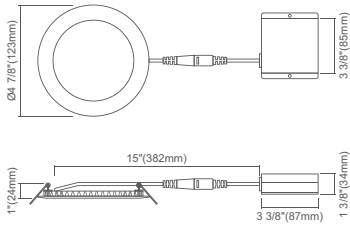

Cut out: $\varnothing 4 \frac{1}{4}$ " (108mm)

4" Square

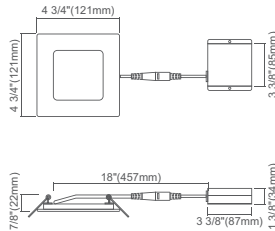

Cut out: $\varnothing 4 \frac{1}{4}$ " (108mm)

6" Round

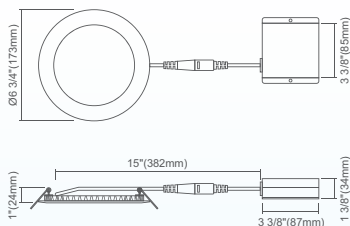

Cut out: $\varnothing 6 \frac{1}{4}$ " (158mm)

6" Square

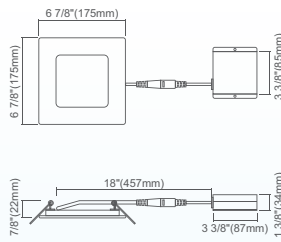

Cut out: $\varnothing 6 \frac{1}{4}$ " (158mm)

8" Round

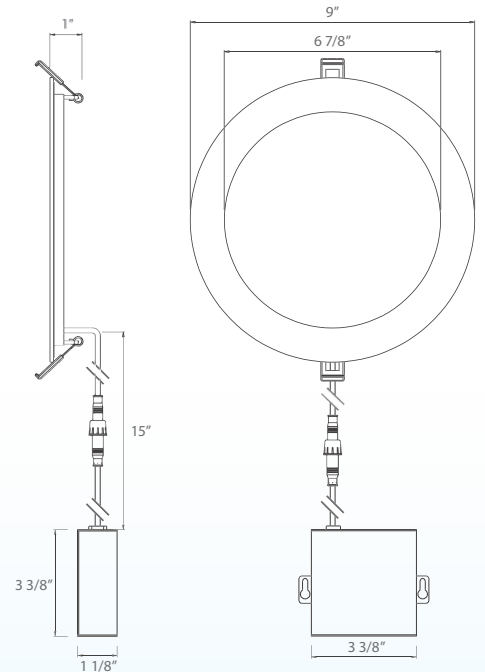

CLIP-ON TRIMS



ACCESSORIES

JBX-EXT
Extension Cable (6'/10')



JBX-HV
High Voltage Driver

CUNV-NC-ICAT
Universal Pre-Mounting Plate

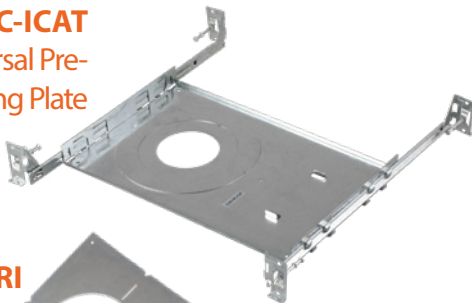

C4-JBX-RI

C6-JBX-RI

C8-JBX-RI



EMB
Emergency Backup

FIXTURE, TRIM, & ACCESSORY REFERENCE TABLES

Fixture Model	Voltage	Watts	Lumens	Color	CRI
LED-SL-PNL-4R-11W-TRI	120V	11w	600	Variable	>90
LED-SL-PNL-4SQ-11W-TRI	120V	11w	600	Variable	>90
LED-SL-PNL-4R-11W-TRI-0/10V	120/277v	11w	600	Variable	>90
LED-SL-PNL-4SQ-11W-TRI-0/10V	120/277v	11w	600	Variable	>90
LED-SL-PNL-6R-14W-TRI	120V	14w	950	Variable	>90
LED-SL-PNL-6SQ-14W-TRI	120V	14w	950	Variable	>90
LED-SL-PNL-6R-14W-TRI-0/10V	120/277v	14w	1,000	Variable	>90
LED-SL-PNL-6SQ-14W-TRI-0/10V	120/277v	14w	1,000	Variable	>90
LED-SL-PNL-8R-18W-TRI	120V	18w	1,200	Variable	>90
LED-SL-PNL-8R-18W-TRI-0/10V	120/277v	18w	1,200	Variable	>90

Trim Model	Description
SL-PNL-4R-TRIM-BLK	4" Round Black Finish Trim
SL-PNL-4R-TRIM-BZ	4" Round Bronze Finish Trim
SL-PNL-4R-TRIM-BN	4" Round Brushed Nickel Trim
SL-PNL-4SQ-TRIM-BLK	4" Square Black Finish Trim
SL-PNL-4SQ-TRIM-BZ	4" Square Bronze Finish Trim
SL-PNL-4SQ-TRIM-BN	4" Square Brushed Nickel Trim
SL-PNL-6R-TRIM-BLK	6" Round Black Finish Trim
SL-PNL-6R-TRIM-BZ	6" Round Bronze Finish Trim
SL-PNL-6R-TRIM-BN	6" Round Brushed Nickel Trim
SL-PNL-6SQ-TRIM-BLK	6" Square Black Finish Trim
SL-PNL-6SQ-TRIM-BZ	6" Square Bronze Finish Trim
SL-PNL-6SQ-TRIM-BN	6" Square Brushed Nickel Trim
SL-PNL-8R-TRIM-BLK	8" Round Black Finish Trim
SL-PNL-8R-TRIM-BZ	8" Round Bronze Finish Trim
SL-PNL-8R-TRIM-BN	8" Round Brushed Nickel Trim

Accessory Model	Description
JBX-EXT-6'	6' J-Box Connector Extension Cable
JBX-EXT-10'	10' J-Box Connector Extension Cable
JBX-11W-277-347V	200-347V Driver for 11W Fixture (4")
JBX-14W-277-347V	200-347V Driver for 14W Fixture (6")
JBX-18W-277-347V	200-347V Driver for 18W Fixture (8")
C4-JBX-RI	4" Rough-In Plate (6 1/2" x 13 1/4")
C6-JBX-RI	6" Rough-In Plate (8 1/2" x 17 1/4")
C8-JBX-RI	8" Rough-In Plate (10 1/2" x 26")
CUNV-NC-ICAT	2/3/4/6" Pre-Mounting Plate