

# SlimLine Surface Mount Bi-Level Motion Sensor



Motion Sensor

**Detail Specifications:**

- Finishes: White
- IP Rating: Wet Location
- 5-CCT: 27/30/35/40/50K Selectable
- Beam Angle: 110°
- Chip: SMD 2835, R9 >50, CRI >90
- 3 Step MacAdam Ellipses
- Operating Temperature: -40° - 114° F
- Lens: Frosted Acrylic, non-yellowing
- Average life (L70) of 50,000 hours

**Applications:**

- General Recessed Lighting
- Residential & Multifamily
- Office and Meeting Rooms
- Education, Healthcare, Retail, Hospitality

**Product Information:**

- AC technology: slim and easy driverless installation
- Edge-lit technology: reduces glare with even light distribution
- Standard white round trim
- 3 Sensor Settings:
  - Off: sensor will be inactive
  - On/off: fixture will turn off after 1 minute
  - Bi-level: fixture will dim to 30% after 1 minute, never turns off

**Driver Options:**

- 120V Triac dimmable down to 5% (only when sensor is de-activated)
- THD: <20% (+/-5% tolerance), PF >0.9, 50/60Hz
- AC Driverless technology
- Flicker Free

**Mounting & Installation:**

- 30/40 Junction Box (including pancake j-box)
- 5": works in 4" recessed can with included friction clips
- 7", 12": works in 6" recessed can with included friction clips
- Surface mount bracket included

**Certifications:**

- ETL Listed for USA and CA
- Energy Star Certified
- CA Title 24 JA8-2022 CEC Listed
- 5 Year Limited Warranty
- FCC CFR 47, GCC Part 15, Subpart B:2017
- IC Rated and ASTM-E283 Air-Tight
- Complies with UL 263, ASTM E119, CAN ULC S101
- Closet Rated

*Round Series*

- LED-SLDSKR-5-12W-5CCT-WH-BMS**  
750lm
- LED-SLDSKR-7-13W-5CCT-WH-BMS**  
1050lm
- LED-SLDSKR-12-23W-5CCT-WH-BMS**  
1900lm

*Specs and model numbers are subject to change with or without notice.*

**CAN CONVERTER**  
(Included)

**FEATURES**

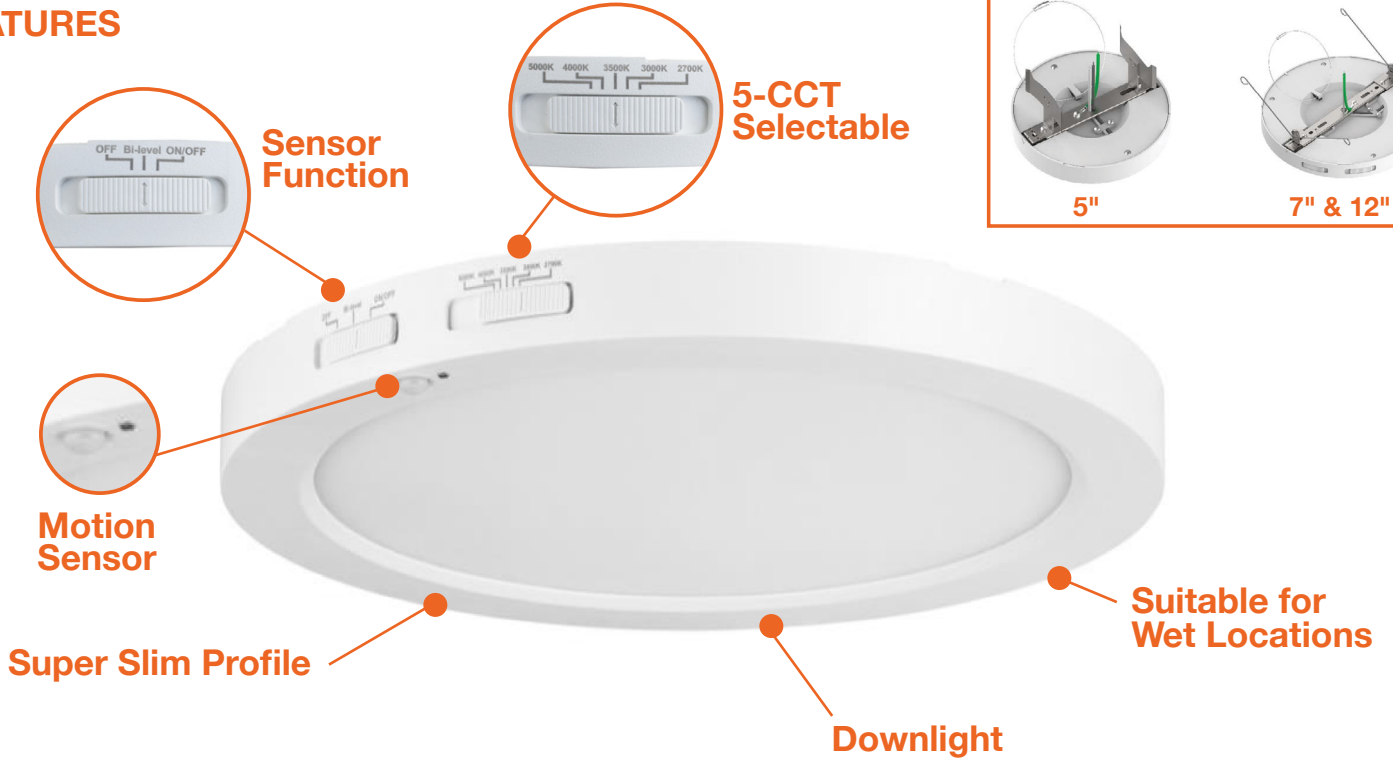

**DIMENSIONS**

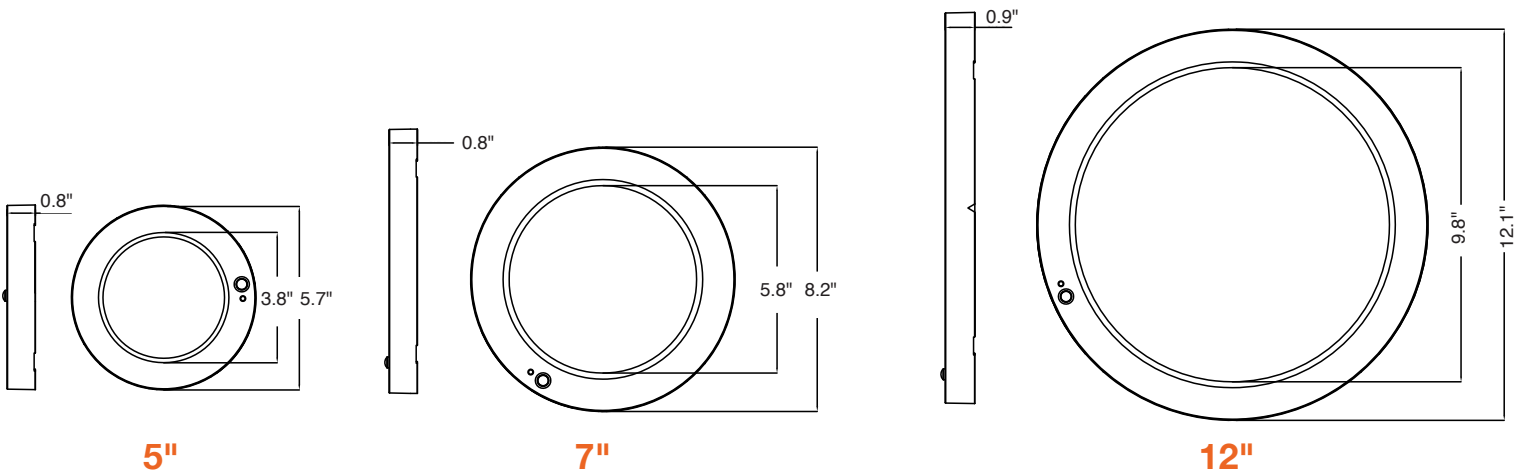

**TESTED COMPATIBLE DIMMERS**

Other dimmers may be compatible but have not been tested. Please contact us for more information.

Lutron	Leviton
S2-LH	6631-PLW
DV-600P	DSM10-1LZ
SELV-300P	6674-P
NTELV-300-WH	IPL06-10Z
DV-603P-LA	
DVELV-300P-AL	

**MOTION SENSOR FUNCTION**

- **OFF:** sensor will be inactive
- **ON/OFF:** fixture will turn off after 1 minute
- **BI-LEVEL:** fixture will dim to 30% after 1 minute, never turns off

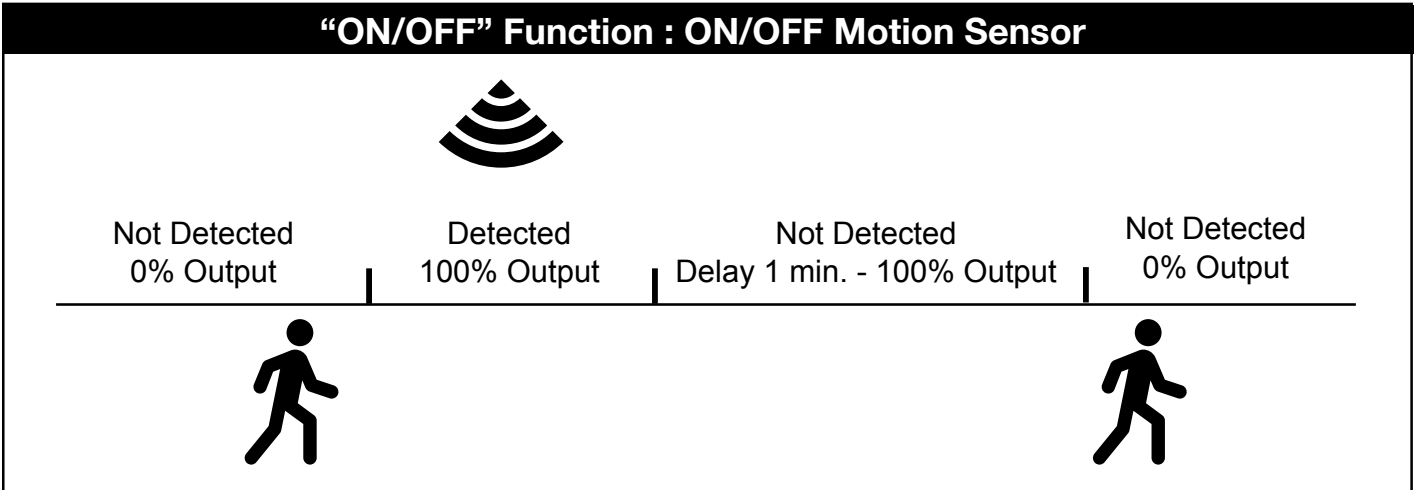
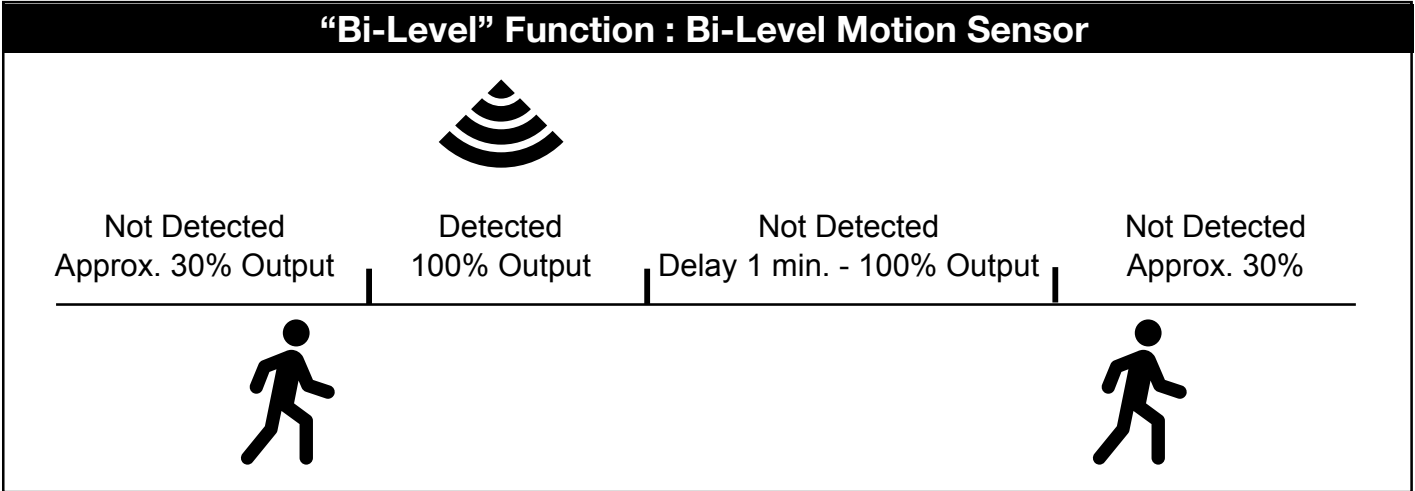
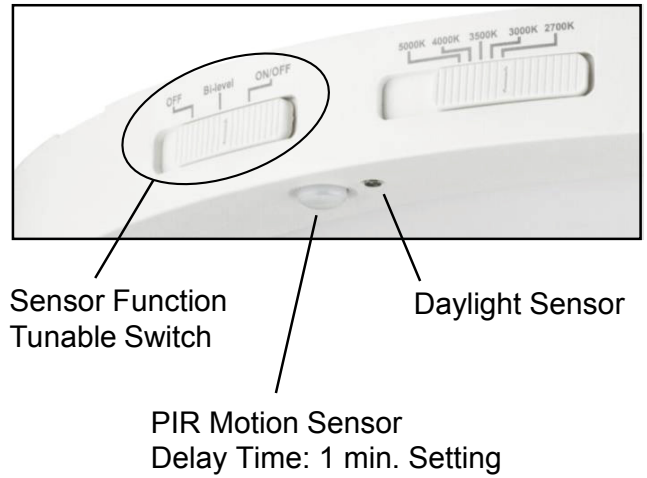
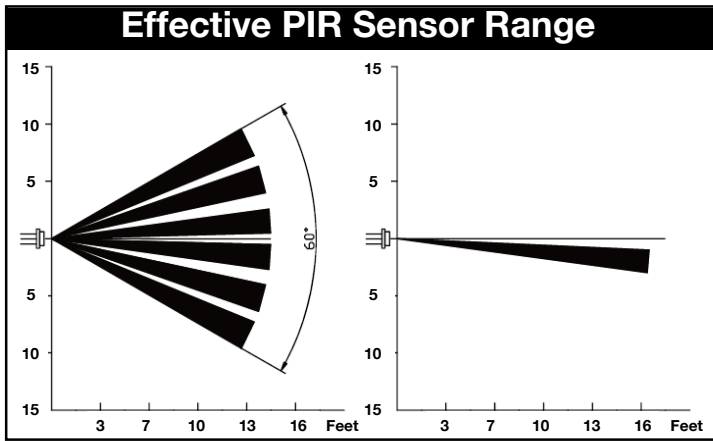

**INSTALLATION**

**Electrical Connection Wiring**

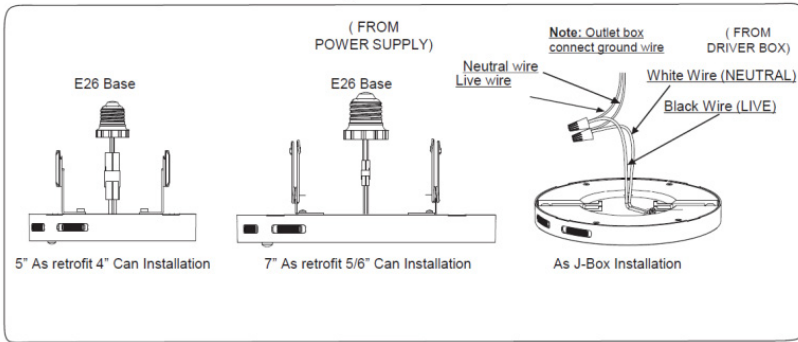

**Installation Bracket Positioning Mark**

